

INSTALLATION DETAIL

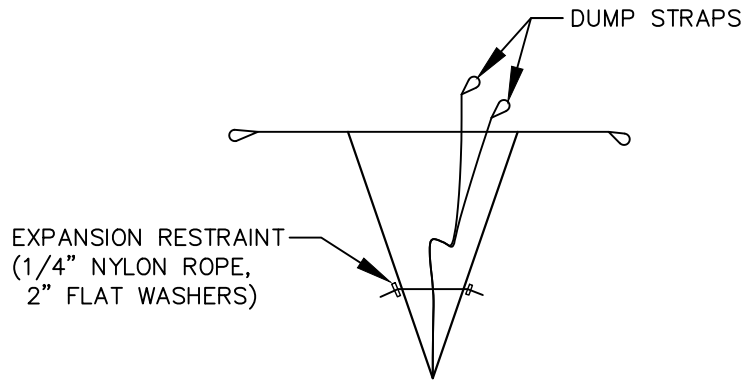

BAG DETAIL

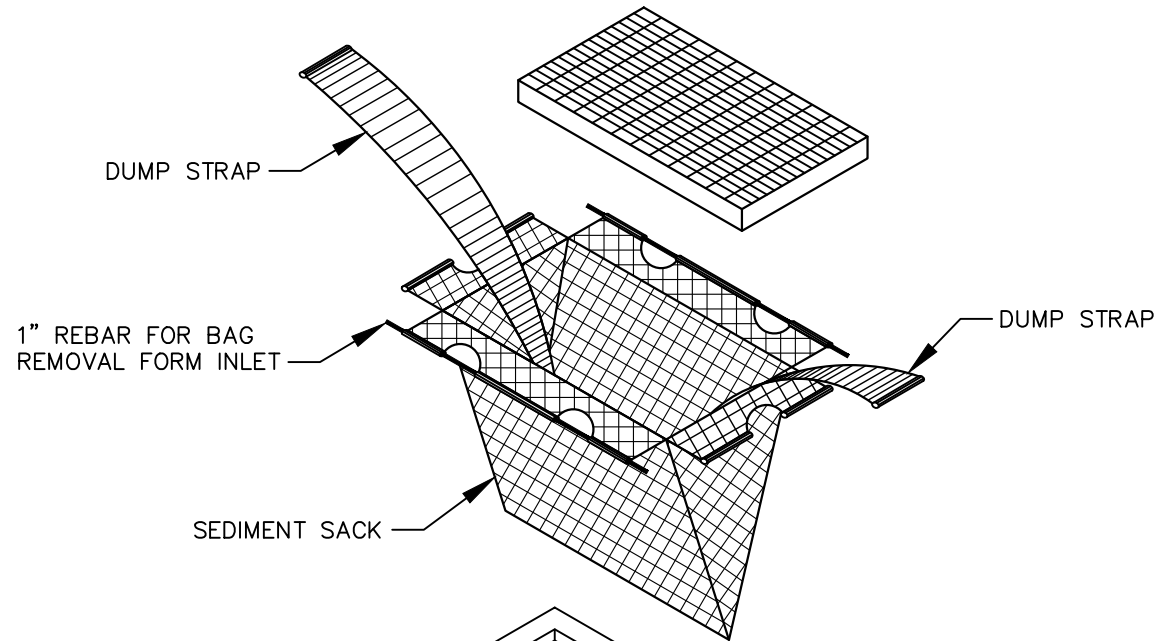
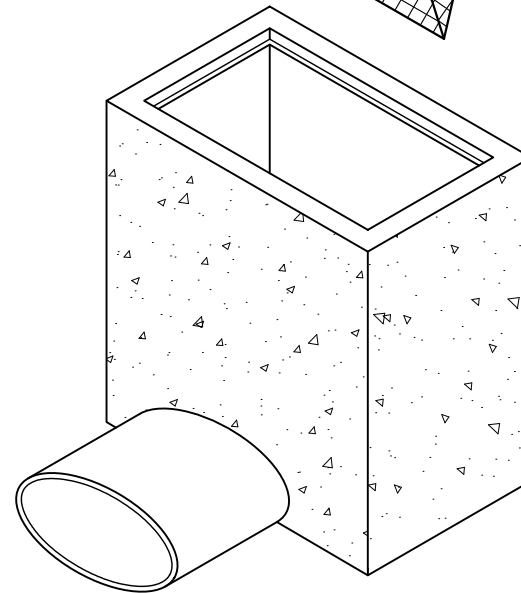

EFFECTIVE: 07/01/21

STANDARD INLET SEDIMENT CONTROL DEVICE

DETAIL No.

4000.19