

RING & COVER SPECIFICATIONS:

1. CLASS 35 GREY IRON.
2. COMPLIES WITH ASTM A48 CL35B.
3. ALL LETTERING SHALL BE CLEAN, CRISP, AND CLEARLY LEGIBLE.
4. DOMESTICALLY MADE & MANUFACTURED IN THE USA.

MINIMUM WEIGHTS	
RING	180
COVER	120
TOTAL	300

- NOTES:**
1. TAP SIZE AND ISOLATION VALVE TO BE SAME SIZE AS AIR VALVE.
 2. ALL PIPING AND FITTINGS, IN THE MANHOLE, SHALL BE 'NO LEAD' BRASS OR BRONZE UNLESS NOTED.
 3. ARV MANHOLE SHALL BE PROVIDED WITHOUT STEPS.
 4. CONCENTRIC CONES MAY BE USED FOR AIR VALVE MANHOLES LESS THAN 5 FEET IN DEPTH.
 5. RESILIENT CONNECTORS OR BOOTS MEETING ASTM C923 SHALL BE USED AT THE MANHOLE AND PIPE INTERFACE.
 6. MANHOLES DEEPER THAN 12 FEET REQUIRE AN EXTENDED BASE.

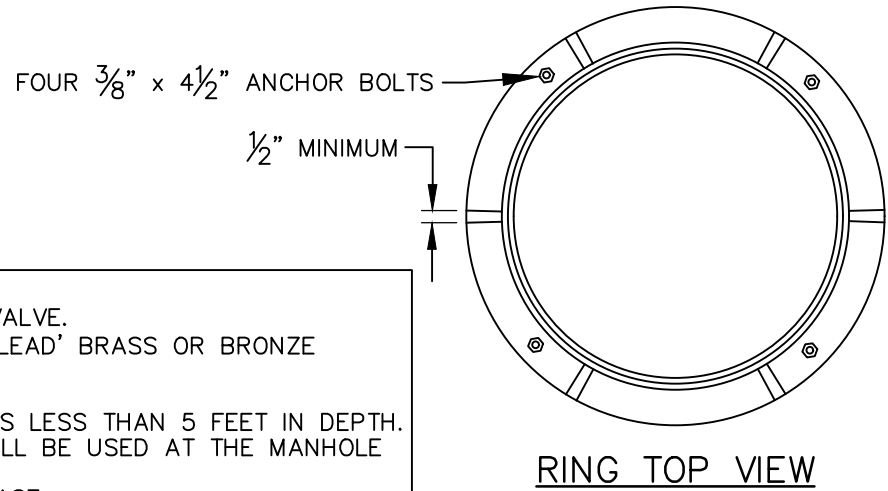

EFFECTIVE: 07/01/21

**STANDARD 2" COMBINATION AIR VALVE
(FOR POTABLE WATER SYSTEMS)**

DETAIL No.
6000.23