

NOTES:

1. CUSTOM SETTER PIPING TO BE NO LEAD BRASS & COPPER TUBING AND SHALL BE EQUIPPED W/ANGLED BALL VALVES & A LOCKABLE BY-PASS FLANGED BALL VALVE.
2. PRECAST CONCRETE BOX WITH ALUMINUM ACCESS HATCH WILL BE AN ACCEPTABLE ALTERNATIVE WITH APPROVAL OF THE DIRECTOR OF UTILITIES.
3. THE INTERIOR OF THE BOX SHALL BE STENCILED WITH THE WORDS "CAUTION RECLAIMED WATER DO NOT DRINK".
4. LOCATE METER REGISTER 5 TO 8 INCHES BELOW COVER.
5. ALL BRASS COMPONENTS SHALL BE 'NO LEAD' BRASS MEETING UNS C89833 AS PER ASTM B584.

NOTE:

TO ENSURE POSITIVE DRAINAGE, THE VAULT SHALL HAVE AN OPEN BOTTOM TO ALLOW DRAINAGE THROUGH STONE.

DIMENSIONS (INCHES)	
A	B
18 3/8"	30 1/8"

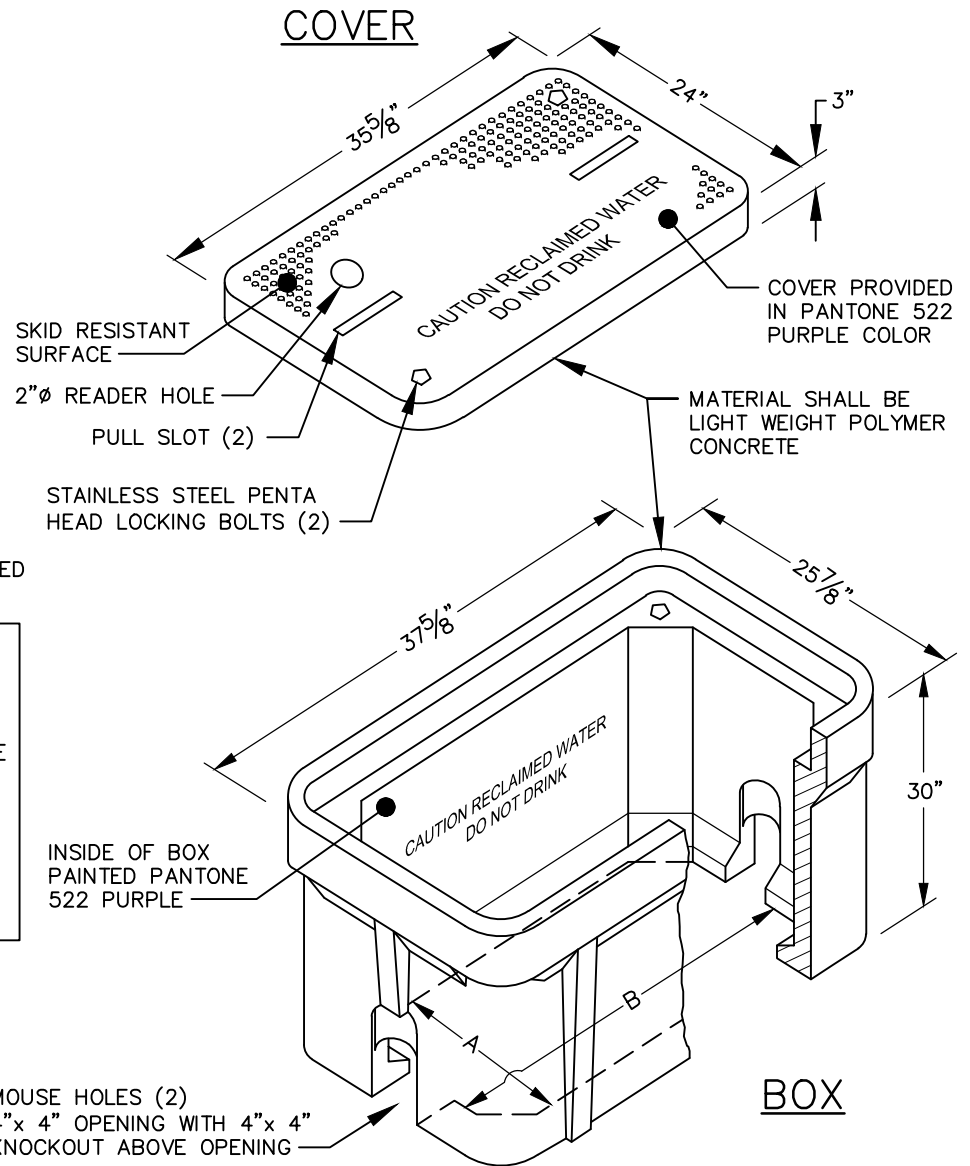

EFFECTIVE: 07/01/21

STANDARD 1 1/2" & 2" RECLAIMED WATER METER INSTALLATION & BOX

DETAIL No.

6500.04