

PLAN VIEW
(SEE SHEET 1 OF 2 FOR SECTION VIEW)

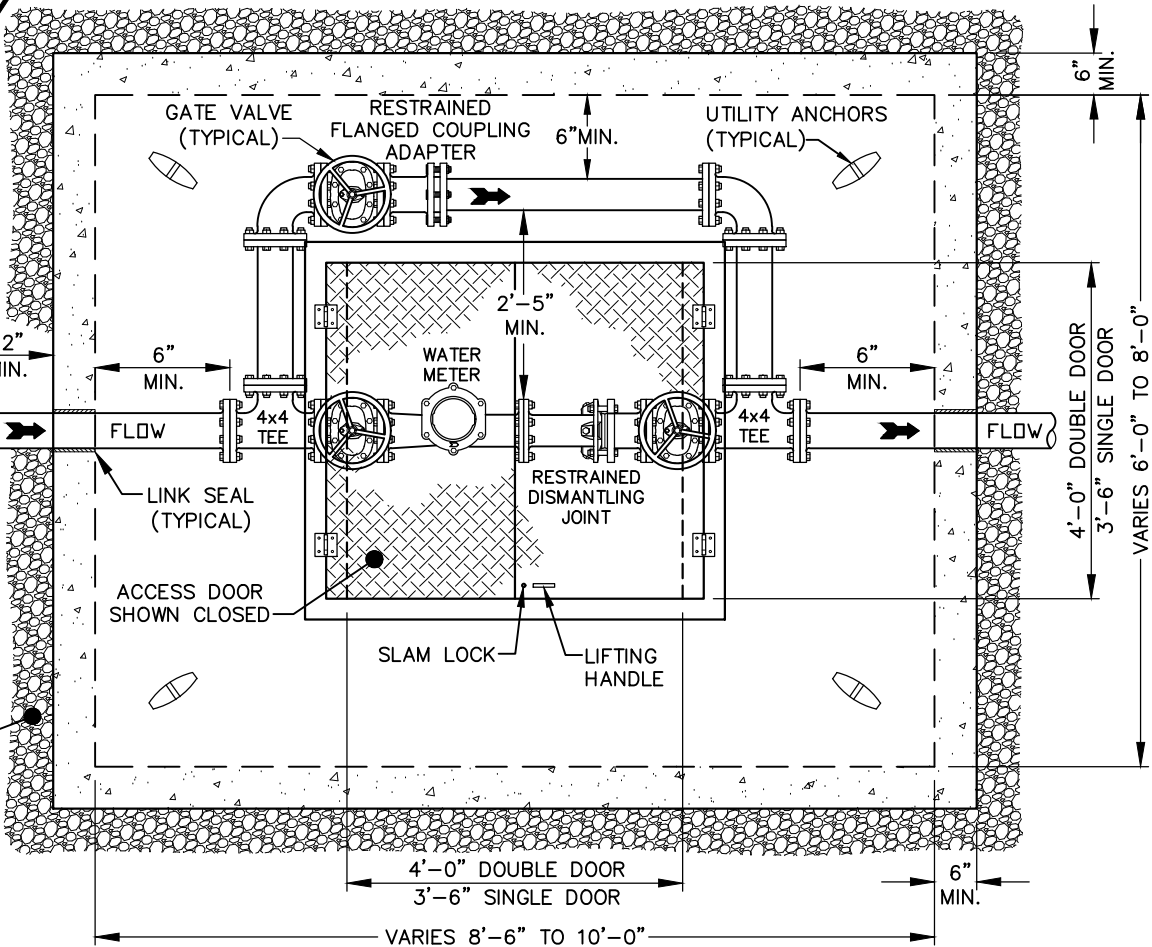
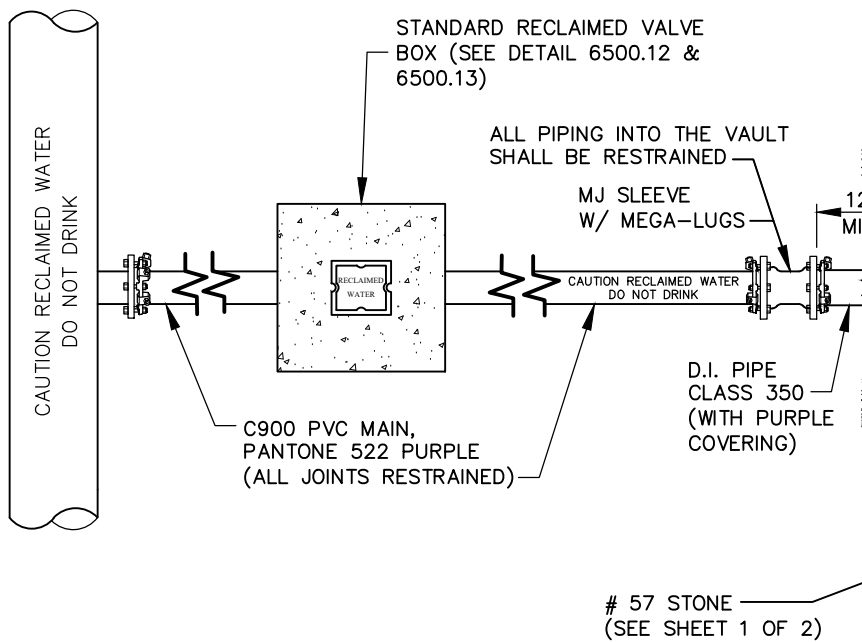

STANDARD RECLAIMED WATER 3" OR 4" METER INSTALLATION & BOX

EFFECTIVE: 07/01/21

DETAIL No.
6500.05
SHEET 2 OF 2