

COVER TOP VIEW

- RING & COVER SPECIFICATIONS:**
1. CLASS 35 GREY IRON.
 2. COMPLIES WITH ASTM A48 CL35B.
 3. ALL LETTERING SHALL BE CLEAN, CRISP, AND CLEARLY LEGIBLE.
 4. DOMESTICALLY MADE & MANUFACTURED IN THE USA.

MINIMUM WEIGHTS	
RING	180
COVER	120
TOTAL	300

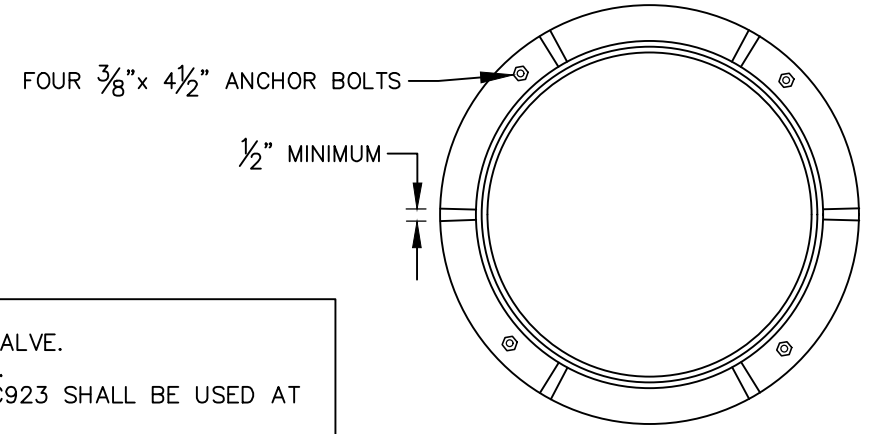

RING TOP VIEW

- NOTES:**
1. ISOLATION GATE VALVE TO BE SAME SIZE AS AIR VALVE.
 2. ARV MANHOLE SHALL BE PROVIDED WITHOUT STEPS.
 3. RESILIENT CONNECTORS OR BOOTS MEETING ASTM C923 SHALL BE USED AT THE MANHOLE AND PIPE INTERFACE.
 4. INSIDE OF MANHOLE TO BE PAINTED PANTONE 522 PURPLE WITH THE WORDS "CAUTION RECLAIMED WATER DO NOT DRINK" STENCILED ON TWO SIDES.
 5. MANHOLES DEEPER THAN 12 FEET REQUIRE AN EXTENDED BASE.



EFFECTIVE: 07/01/21

**STANDARD 3" AND GREATER COMBINATION AIR VALVE
(FOR RECLAIMED WATER)**

DETAIL No.
6500.11