

PLAN VIEW

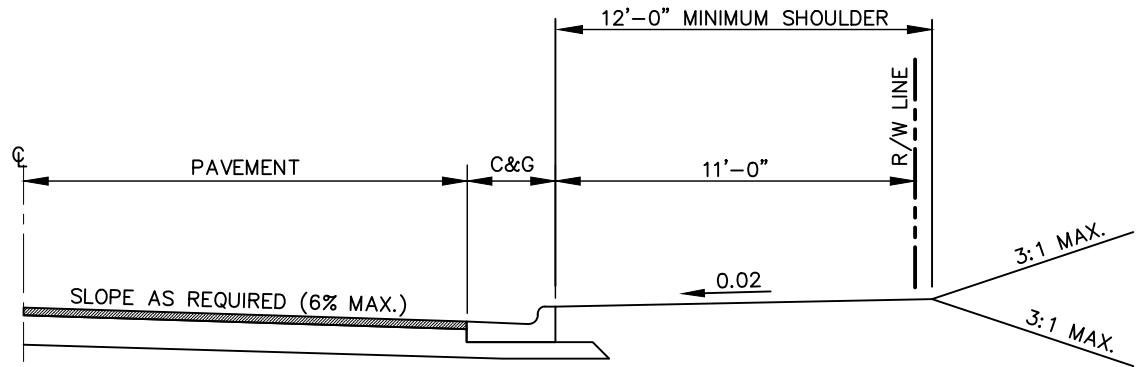

SECTION 'A-A'  
WITH CURB & GUTTER

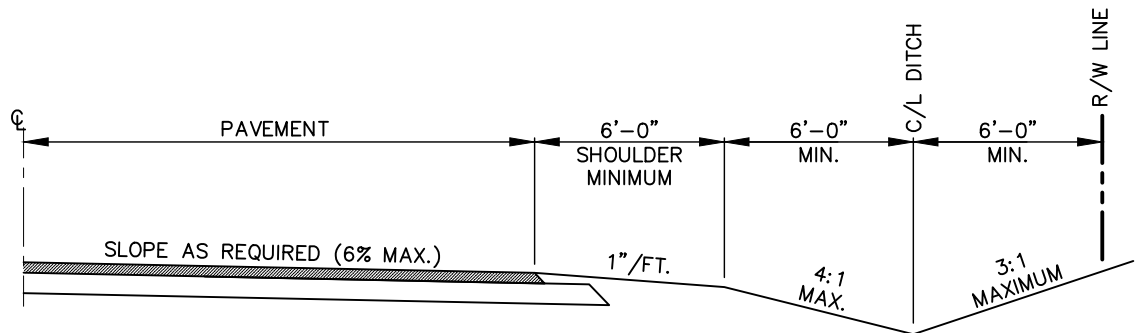

SECTION 'A-A'  
WITHOUT CURB & GUTTER



EFFECTIVE: 07/01/22

CUL-DE-SAC SECTION

DETAIL No.

3100.07