

DESIRABLE DRIVEWAY GRADES

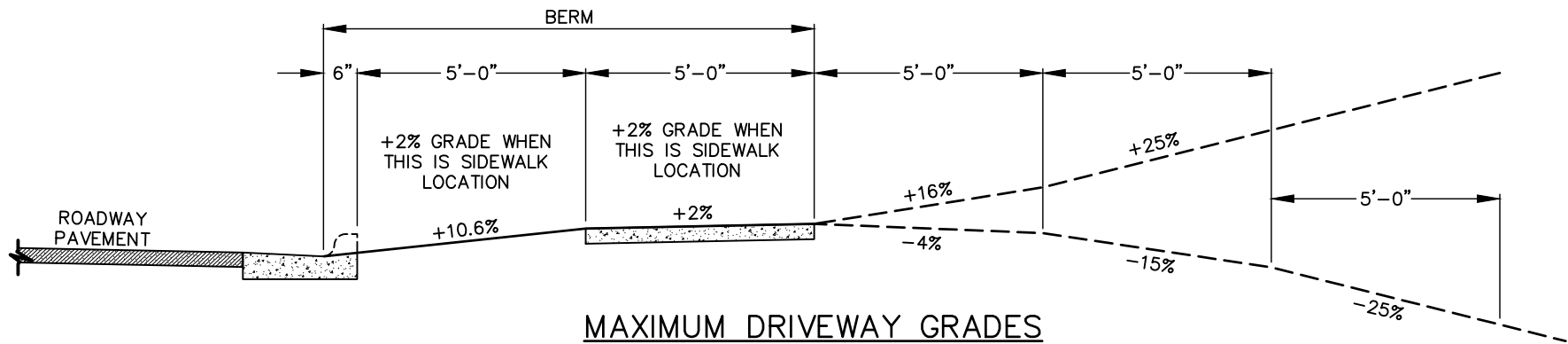

MAXIMUM DRIVEWAY GRADES



EFFECTIVE: 07/01/22

DRIVEWAY APRON - TYPE I & II  
DRIVEWAY GRADES

DETAIL No.

3200.02