

NOTES:

1. VERTICAL SPACING = 16 INCHES ON CENTER, ON VERTICAL WALL ONLY.
2. STEPS TO PROTRUDE MINIMUM 5 INCHES FROM FACE OF STRUCTURE WALL.
3. STEPS SHALL MEET THE REQUIREMENTS OF ASTM C478 IN ADDITION TO A HORIZONTAL PULL-OUT LOAD OF 1000 LBS. WHEN INSTALLED.
4. ALL STEPS SHALL BE VERTICALLY ALIGNED IN A STRAIGHT LINE.
5. NO STEPS LOCATED INSIDE MANHOLE CHIMNEY.
6. ONLY THE FIRST AND LAST STEP SHALL BE PROVIDED IN MANHOLES.

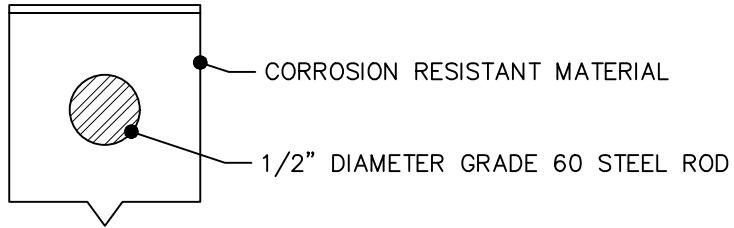

SECTION VIEW

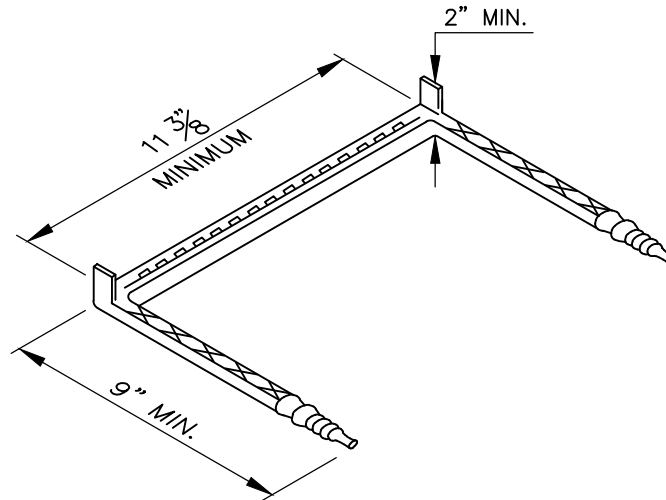

ENCAPSULATED STEEL STEP



EFFECTIVE: 07/01/22

MANHOLE STEPS

DETAIL No.

7000.05