

2" GALVANIZED VENT AT HIGH END OF CASING.
 VENT TO HAVE INSECT SCREEN WELDED TO END.
 VENT TO BE USED FOR ALL STREAM CROSSINGS,
 NOT REQUIRED FOR TYPICAL ROADWAY BORES.

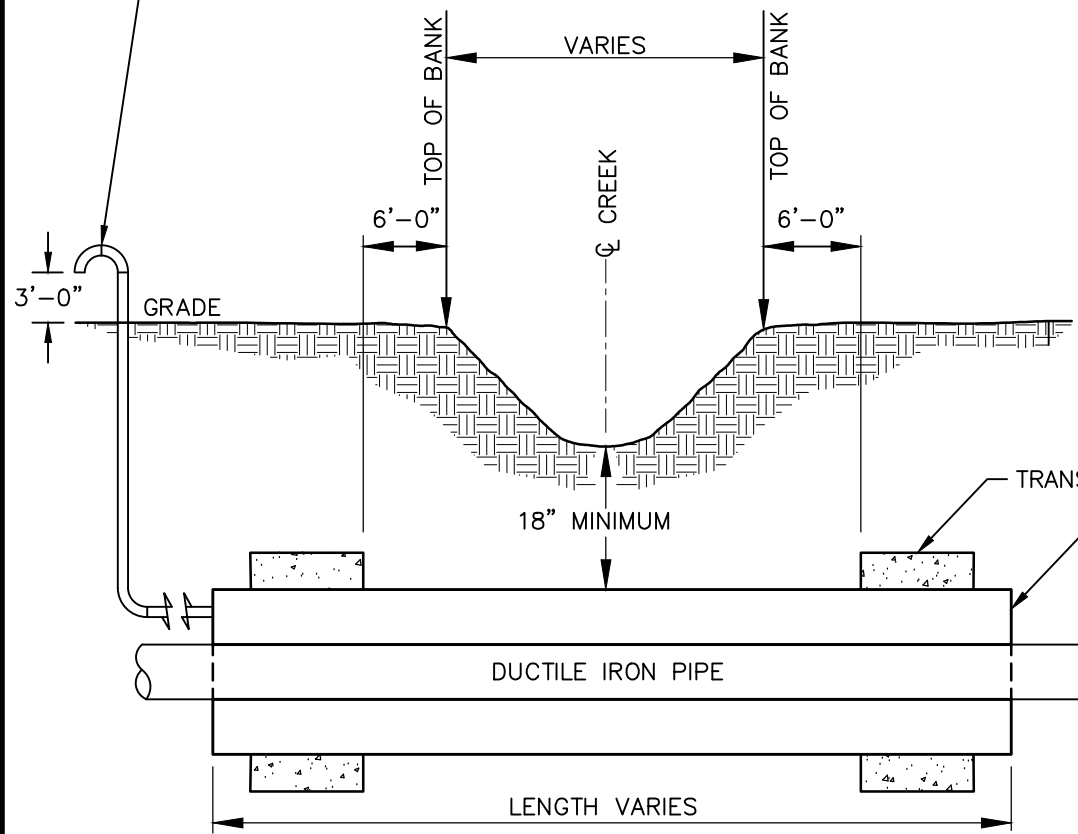

CROSS SECTION

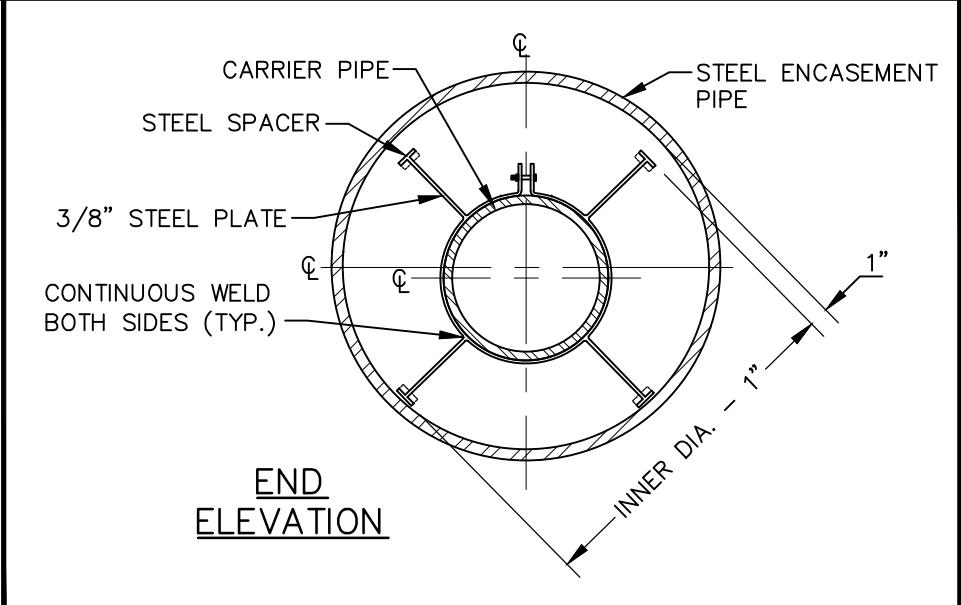

END ELEVATION

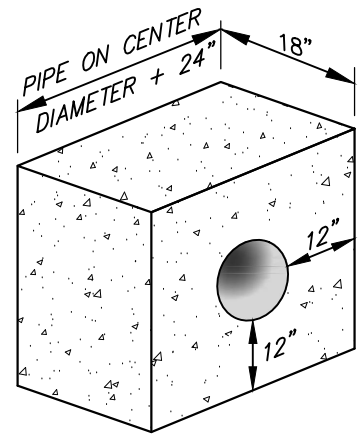

TRANSITION COLLAR DETAIL

- NOTES:**
1. CONCRETE SHALL BE 3,000 P.S.I.
 2. VENT OPENING SHALL BE INSTALLED 12" ABOVE 100-YEAR FLOOD ELEVATION OR 36" ABOVE EXISTING GRADE, WHICHEVER IS HIGHER.



EFFECTIVE: 07/01/22

STANDARD STEEL ENCASEMENT FOR STREAM CROSSING

DETAIL No.
 7000.26