

MAIN SIZE	END PIPE SIZE
4" - 12"	2" BLOW-OFF
14" & GREATER	AS APPROVED BY CARY

**NOTES:**

1. FOR MAINS THAT ARE TO BE EXTENDED, USE A VALVE EQUAL TO THE MAIN SIZE AS THE BLOW-OFF VALVE AND THEN REDUCE TO THE 2 INCH STANDPIPE.
2. PIPE SHALL BE RESTRAINED AWAY FROM THE TAPPED CAP AS SPECIFIED IN SECTION 6010.
3. STANDPIPE SHALL BE INSTALLED SO THAT IT IS CENTERED TO THE MAIN.

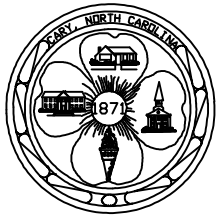
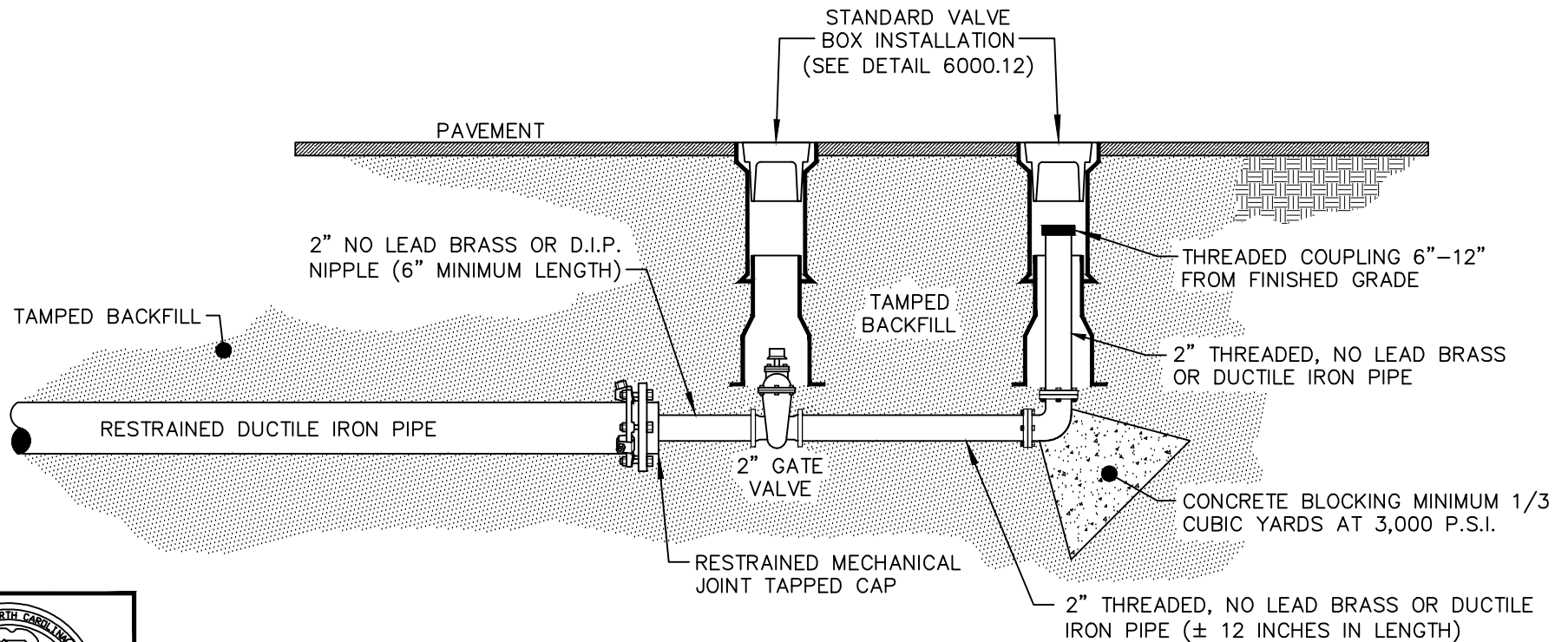

EFFECTIVE: 07/01/23

**STANDARD 2" BLOW-OFF ASSEMBLY**

DETAIL No.

6000.18