

ELEVATION

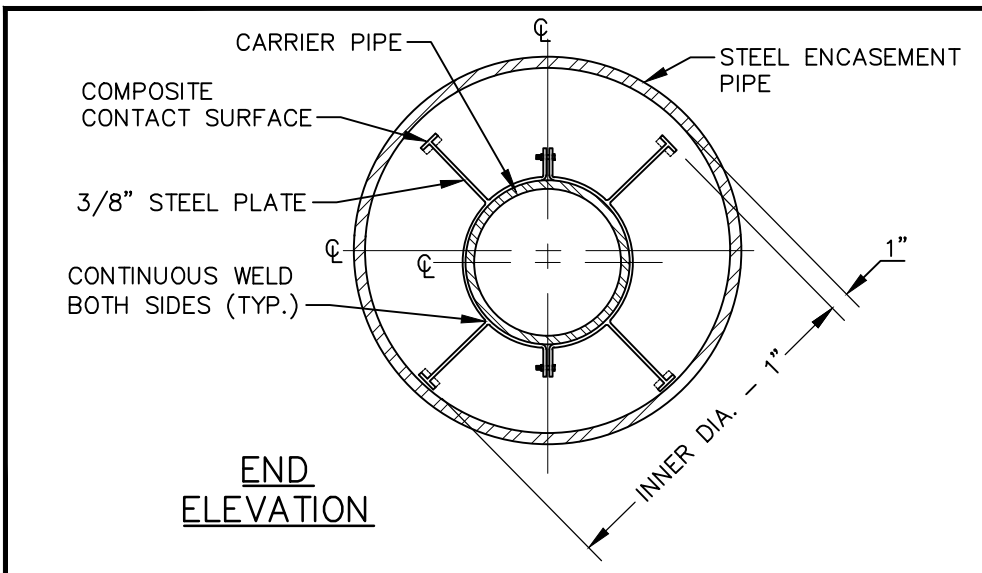

END ELEVATION

- NOTES:**
1. STEEL SPACERS SHALL BE USED FOR SUPPORT OF THE CARRIER PIPE WITHIN THE CASING PIPE. FOR RAILROAD CROSSINGS WITH IMPRESSED CURRENT OR WITH ENCASEMENT PIPES REQUIRING CATHODIC PROTECTION, STEEL SPACERS WITH **EPDM** OR COMPOSITE CONTACT SURFACES SHALL BE USED.
 2. A MINIMUM SPACING OF 2 SPACERS PER JOINT OF CARRIER PIPE SHALL BE REQUIRED. 3 SPACERS ARE REQUIRED FOR CARRIER PIPE \geq 36 INCHES.
 3. THE SPACERS SHALL BE LOCATED EVENLY ALONG THE CARRIER PIPE SUCH THAT EACH SPACER SUPPORTS THE SAME UNIT WEIGHT OF THE CARRIER MAIN.
 4. THE PROPOSED ENCASEMENT PIPE & CARRIER PIPE SHALL COMPLY WITH ALL APPLICABLE CARY & OTHER JURISDICTIONAL REQUIREMENTS, WHICHEVER IS MORE STRINGENT.
 5. NO BLASTING ALLOWED IN RAILROAD RIGHT-OF-WAY.



EFFECTIVE: 07/01/23

STEEL ENCASEMENT & CARRIER PIPE - UNDER RAILROAD

DETAIL No.
6000.42