

- NOTES:**
1. WATER METER SHALL NOT BE LOCATED IN AREAS SUBJECT TO VEHICULAR TRAFFIC.
 2. ALL METER BOXES AND LIDS SHALL BE APPROVED BY CARY.
 3. ALL SERVICE LINES, VALVES AND FITTINGS SHALL COMPLY WITH AWWA C800.
 4. THE INTERIOR AND EXTERIOR OF THE BOX AND LID SHALL BE COLORED PANTONE 522 PURPLE.
 5. ALL RELOCATIONS OF EXISTING OR PERMITTED RECLAIMED WATER INFRASTRUCTURE INCLUDING SERVICE PIPING AND METER BOXES SHALL BE PERMITTED AND INSPECTED IN CONFORMANCE WITH CARY POLICIES AND PROCEDURES.
 6. BOX AND LID SHALL BE CAST IRON, ASTM A48, CLASS 25.
 7. ALL BRASS COMPONENTS SHALL BE 'NO LEAD' BRASS MEETING UNS C89833 AS PER ASTM B584.
 8. MARKING TAPE SHALL BE INSTALLED FOR ALL SERVICE CONNECTIONS FROM THE MAIN LINE TO THE METER FOR ALL NEW CONSTRUCTION OR RETROFIT INSTALLATIONS USING OPEN TRENCH METHODS.

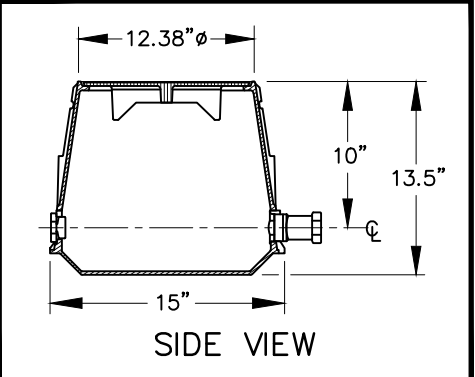
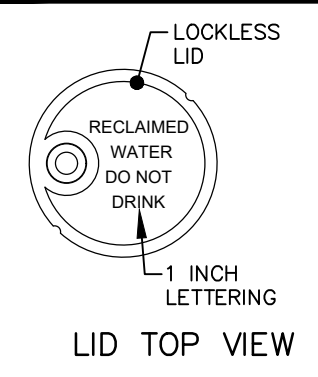

EFFECTIVE: 07/01/23

STANDARD 1" RECLAIMED WATER SERVICE & METER BOX FOR ROADWAY DITCH SECTION WITHOUT CURB & GUTTER

DETAIL No.
6500.03