

PLAN VIEW

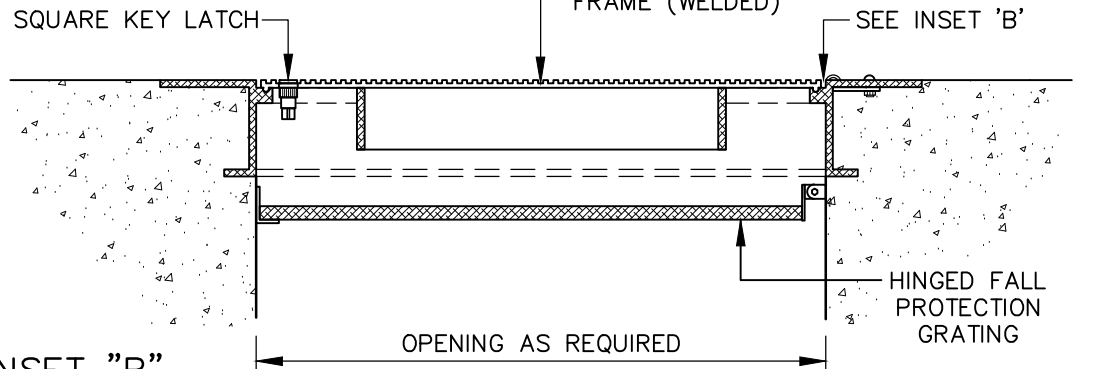

SECTION "A-A"

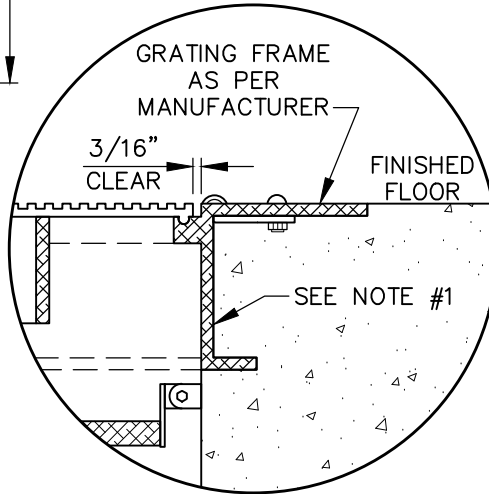

INSET "B"

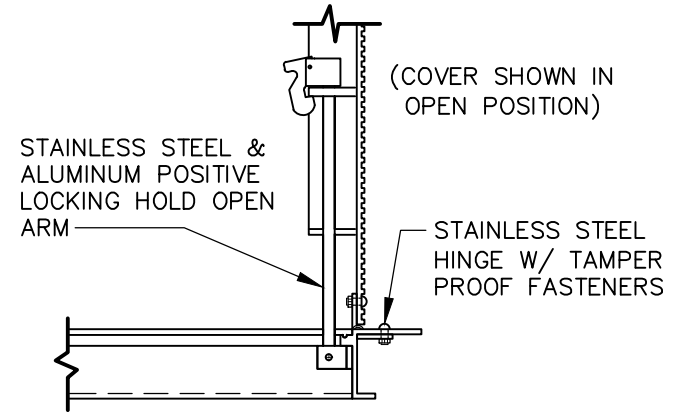

DETAIL

NOTES:

1. ALL ALUMINUM SURFACES IN CONTACT WITH CONCRETE OR GROUT SHALL BE COATED WITH BITUMINOUS MATERIAL FOR PROTECTION.
2. HATCHES SHALL BE SINGLE OR DOUBLE HATCH DEPENDING ON OPENING SIZE AND MANUFACTURER'S RECOMMENDATIONS.
3. HATCH SHALL BE RATED FOR H-20 LOADING.



EFFECTIVE: 07/01/23

ALUMINUM ACCESS HATCH

DETAIL No.

7500.06