

PLAN VIEW

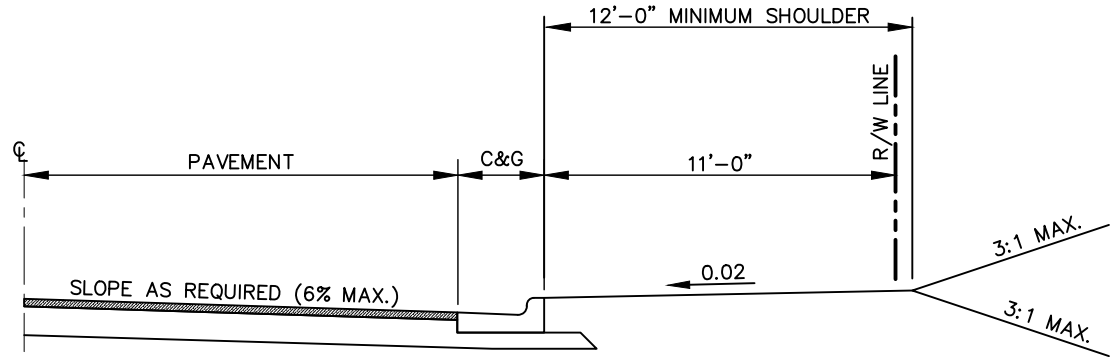

SECTION 'A-A'
WITH CURB & GUTTER

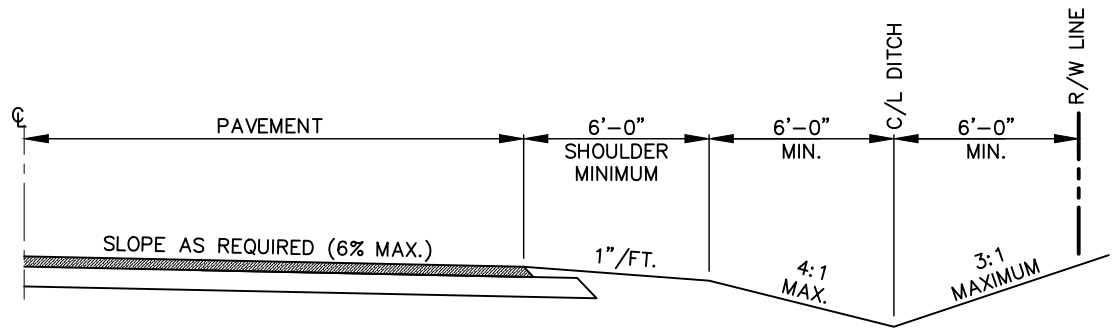

SECTION 'A-A'
WITHOUT CURB & GUTTER

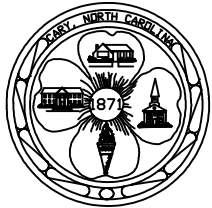

EFFECTIVE:07/01/24

CUL-DE-SAC SECTION

DETAIL No.

3100.07