

PLAN VIEW

NOTES:

1. THRUST COLLAR SHALL ONLY BE USED IF OTHER RESTRAINING METHODS CANNOT.
2. THRUST COLLARS FOR PIPE BEYOND 12 INCHES SHALL BE DESIGNED BY THE ENGINEER.
3. TWELVE (12) #7 BARS SHALL BE USED IN EACH COLLAR.

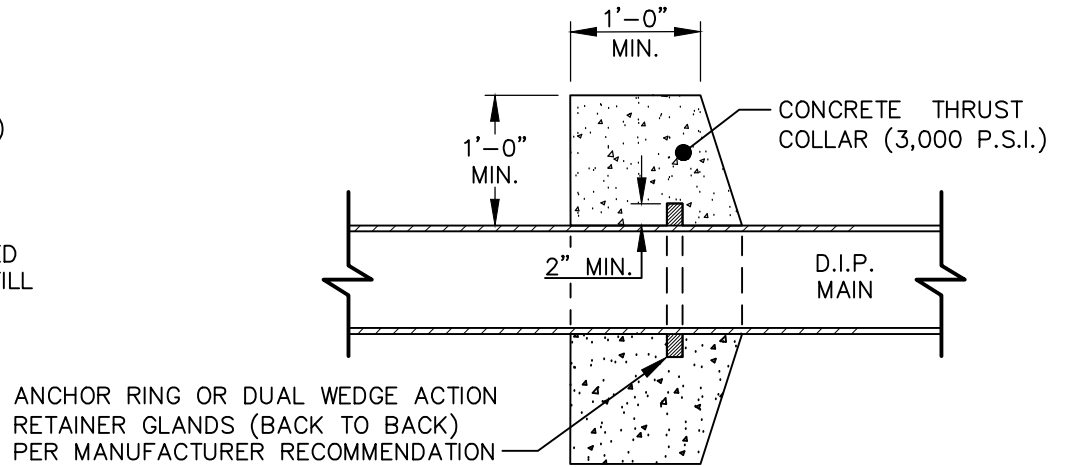

PROFILE VIEW

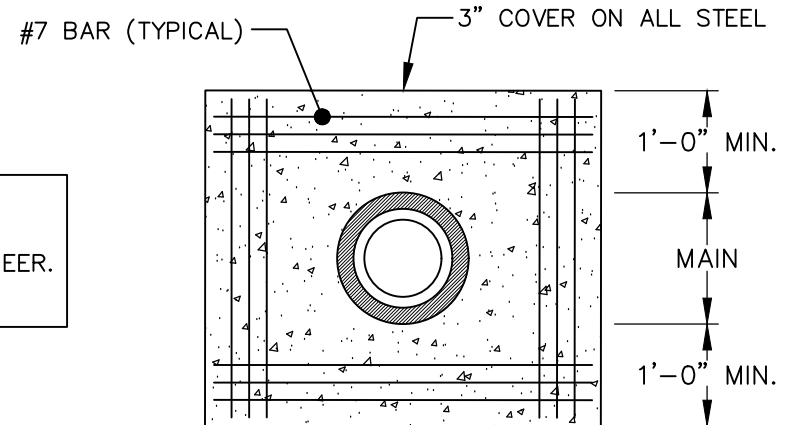

REINFORCING CROSS SECTION

**STANDARD THRUST COLLAR INSTALLATION
(FOR PIPE DIAMETERS 4" - 12")**

DETAIL No.

6000.22



EFFECTIVE: 07/01/24