

### FIELD ADJUSTMENT INSTRUCTIONS

1. REMOVE THE BODY FROM THE TOP OF THE INDICATOR POST ASSEMBLY.
2. CUT THE REQUIRED LENGTH OFF THE BOTTOM OF THE STANDPIPE FOR THE GROUND LINE TO MATCH UP WITH STANDPIPE GROUND LINE MARK.
3. CUT THE 1 INCH SQ. EXTENSION AT A DISTANCE OF 9 INCHES ABOVE THE TOP OF THE STANDPIPE.
4. SET THE "OPEN" AND "SHUT" TARGETS FOR THE APPROPRIATE VALVE SIZE.
5. RE-ATTACH THE BODY TO THE TOP OF THE INDICATOR POST ASSEMBLY.
6. ALL POST INDICATOR VALVES SHALL BE INSTALLED WITH AN ELECTRONIC UL LISTED TAMPER SWITCH.
7. THERE SHALL BE 36 INCHES OF UNOBSTRUCTED CLEARANCE AROUND THE PERIMETER OF ALL POST INDICATOR VALVES.
8. POST INDICATOR VALVE SHALL BE LOCATED AT A MINIMUM 40 FEET FROM BUILDING.

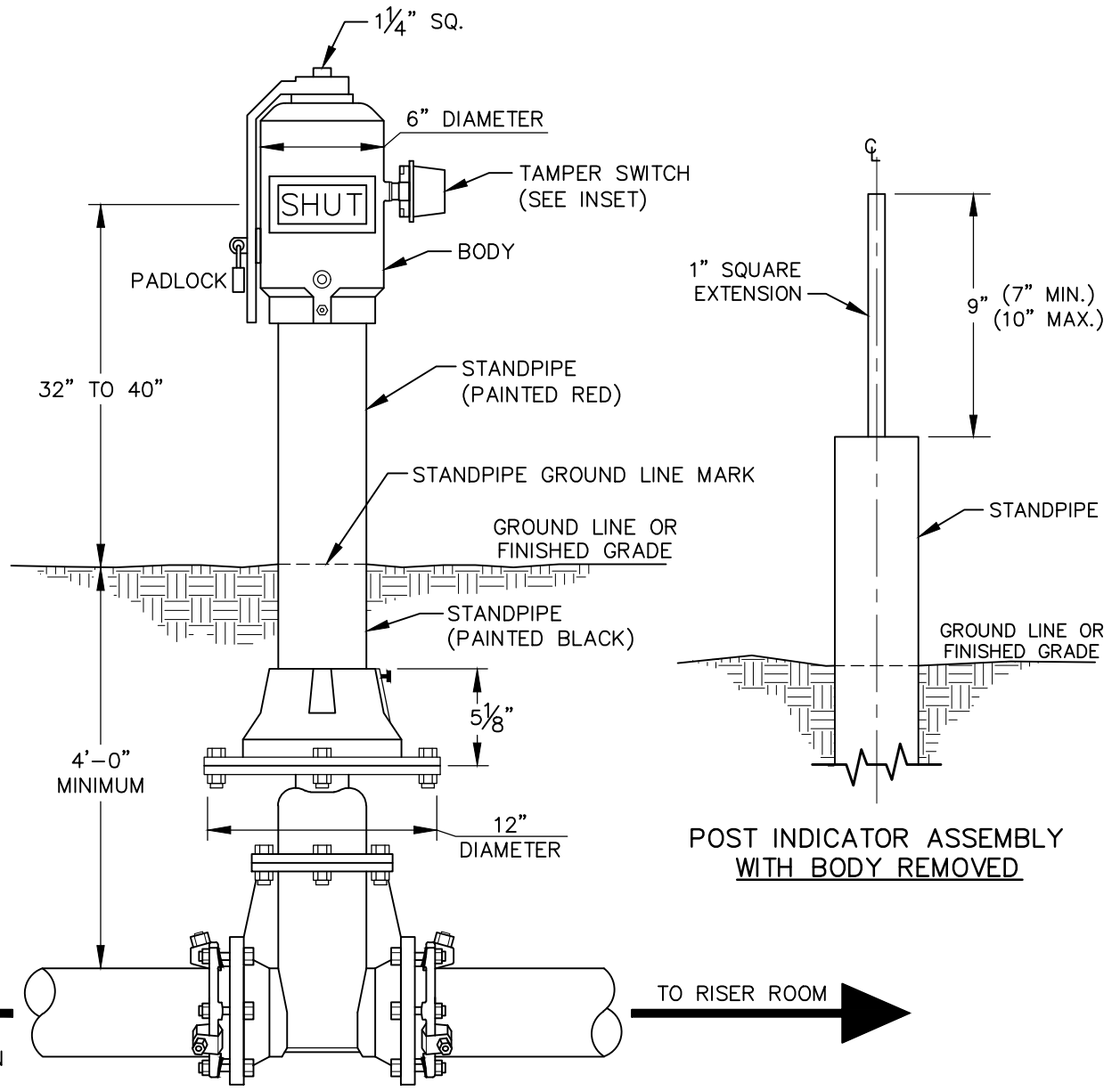
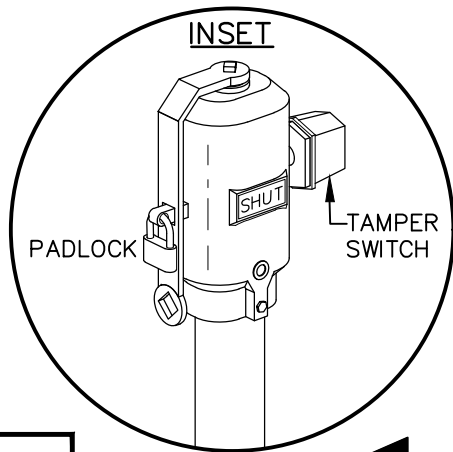

STANDARD POST INDICATOR VALVE

DETAIL No.

6000.30



EFFECTIVE: 07/01/24