

COVER TOP VIEW

- RING & COVER SPECIFICATIONS:**
1. CLASS 35 GREY IRON.
 2. COMPLIES WITH ASTM A48 CL35B.
 3. MANHOLE COVER TO BE PAINTED PANTONE 522 PURPLE, AT MINIMUM 10 MILS.
 4. ALL LETTERING SHALL BE CLEAN, CRISP, AND CLEARLY LEGIBLE.
 5. DOMESTICALLY MADE & MANUFACTURED IN THE USA.

MINIMUM WEIGHTS	
RING	180
COVER	120
TOTAL	300

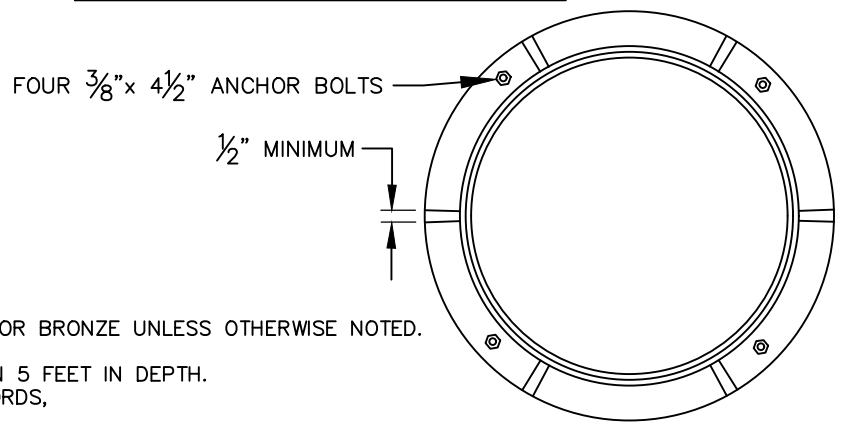

RING TOP VIEW

- NOTES:**
1. TAP SIZE AND ISOLATION VALVE TO BE SAME SIZE AS AIR VALVE.
 2. ALL PIPING AND FITTINGS, IN THE MANHOLE, SHALL BE NO LEAD BRASS OR BRONZE UNLESS OTHERWISE NOTED.
 3. ARV MANHOLE SHALL BE PROVIDED WITHOUT STEPS.
 4. CONCENTRIC CONES MAY BE USED FOR AIR VALVE MANHOLES LESS THAN 5 FEET IN DEPTH.
 5. INSIDE OF MANHOLE TO BE PAINTED PANTONE 522 PURPLE WITH THE WORDS, "CAUTION RECLAIMED WATER DO NOT DRINK", STENCILED ON TWO SIDES.
 6. RESILIENT CONNECTORS OR BOOTS MEETING ASTM C923 SHALL BE USED AT THE MANHOLE AND PIPE INTERFACE.
 7. MANHOLES DEEPER THAN 12 FEET REQUIRE AN EXTENDED BASE.

**STANDARD 2" COMBINATION AIR VALVE MANHOLE
(FOR RECLAIMED WATER)**

DETAIL No.
6500.10

EFFECTIVE: 07/01/24