

ELEVATION

- NOTES:**
1. STEEL SPACERS SHALL BE USED FOR SUPPORT OF THE CARRIER PIPE WITHIN THE CASING PIPE.
 2. A MINIMUM SPACING OF 2 SPACERS PER JOINT OF CARRIER PIPE SHALL BE REQUIRED. 3 SPACERS ARE REQUIRED FOR CARRIER PIPE ≥ 36 INCHES.
 3. THE SPACERS SHALL BE LOCATED EVENLY ALONG THE CARRIER PIPE SUCH THAT EACH SPACER SUPPORTS THE SAME UNIT WEIGHT OF THE CARRIER MAIN.
 4. FOR CASING SIZE SEE STANDARD SPECIFICATION SECTION 6500.
 5. RECLAIMED WATER LINE SHALL BE PVC WITH RESTRAINED JOINTS.
 6. VENT OPENING SHALL BE INSTALLED 12" ABOVE 100-YEAR FLOOD ELEVATION OR 36" ABOVE EXISTING GRADE, WHICHEVER IS HIGHER.

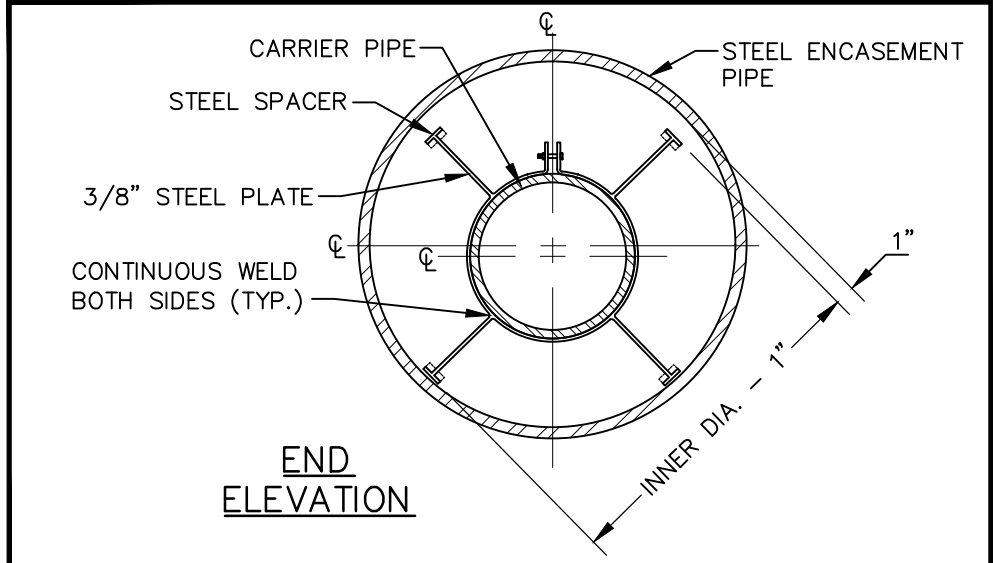

END ELEVATION



EFFECTIVE: 07/01/24

STEEL ENCASEMENT & CARRIER PIPE

DETAIL No.
6500.20