

SECTION VIEW

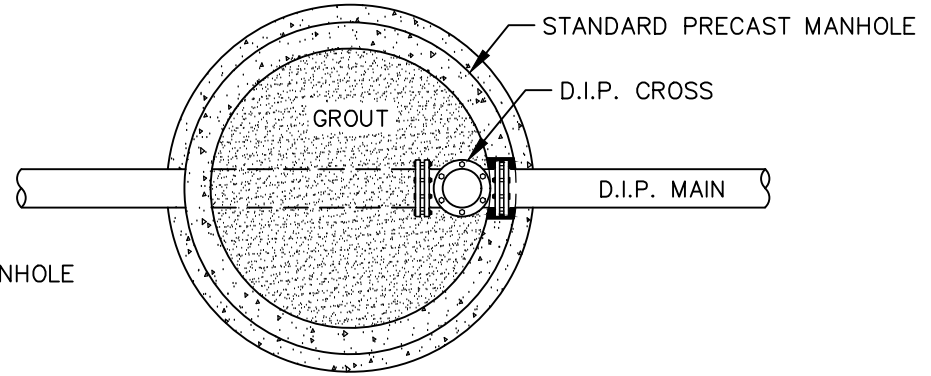

SECTION A-A

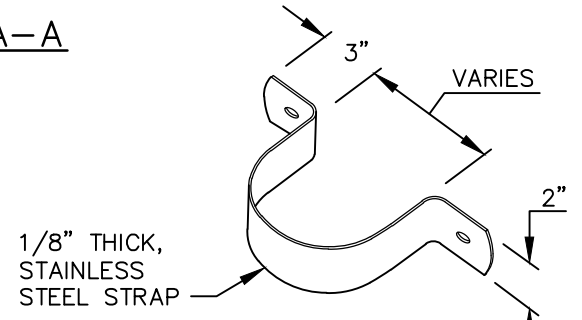

STRAP DETAIL

- NOTES:**
1. INSIDE DROP MANHOLES SHALL ONLY BE ALLOWED BY WRITTEN PERMISSION OF CARY UTILITIES DEPARTMENT.
 2. ONE INSIDE DROP ALLOWED FOR 5 FOOT MANHOLE.
 3. PIPE SIZE FOR DROP TO EQUAL INFLOW SEWER PIPE SIZE.
 4. MECHANICAL JOINT TO BE USED.
 5. ALL MANHOLE CONNECTIONS SHALL BE CORED.
 6. DROP MANHOLE MANDATORY WHEN DIFFERENTIAL BETWEEN INVERTS IS GREATER THAN 20 INCHES.
 7. STRAP INTERVALS OF 18 INCHES SHALL BE USED ON ALL DROPS GREATER THAN 5 FEET.
 8. USE 1/2 INCH DIAMETER EXPANSION TYPE STAINLESS STEEL CINCH BOLTS WITH STAINLESS STEEL WASHERS AND NUTS TO ATTACH STRAPS.
 9. PROVIDE ONLY FIRST AND LAST STEP IN MANHOLE.



EFFECTIVE: 07/01/24

STANDARD INSIDE DROP MANHOLE

DETAIL No.

7000.15